

Profy Advance



**Instructions for use and routine
maintenance**

Index

General information	5
General information: Natural Cool	7
Machine description	8
Package content	9
Machine description - control panel	9
Machine description – electrical connections	10
Machine description – water connections.....	10
Weight and dimensions	11
Transfer, packing and transportation.....	11
Installation position and start-up.....	12
Switching off and storing	15
Repairing the unit.....	16
Routine maintenance - micrometric ceramic nozzles.....	17
Routine maintenance - oil change.....	17
Troubleshooting – causes and solutions.....	18
Lucky3 - General information.....	19
Lucky3 - Meaning of buttons	20
Lucky3 - Available programs	21
Lucky3 - Shift and program selection	21
Lucky3 - Shift and options page selection	21
Lucky3 - Dashboard program	23
Detailed description.....	23
Lucky3 - Info program.....	24
Detailed description	24
Access.....	24
Lucky3 - Setup program	26
Access.....	26
Detailed description.....	26

Lucky3 - Weekly program.....	28
Access.....	28
Detailed description.....	28
Lucky3 - Alarm registry program.....	30
Access.....	30
Detailed description.....	30
Foreseen operation conditions.....	31
Improper use – forbidden use.....	32
Warranty terms and conditions.....	33
Validity.....	33
Warranty Conditions.....	33
Declaration of conformity.....	35

Warning



Read this instruction manual before operating the machine.

General information

This manual provides you with all the information for proper use and maintenance of the machine. Please, carefully follow the instructions given. The manufacturer is not liable for any damage to people or goods, or to the machine itself, if the machine is used differently from what described in this manual. This manual shall be available to the user/technician for correct use of the machine. Information provided in this manual does not replace regulations on safety at work in force. Therefore, the user should comply with the regulations in force in the country where the machine is installed, besides following common sense rules. Do not use the product if you notice and defect or wear that may compromise the original safety standards. The user or the maintenance technician must report any fault to the supplier. The machine is meant for specific applications. Do not modify it and/or use it for applications other than the specified ones. Instructions, drawings, tables and all the contents of this document are confidential technical documentation and exclusive property of the manufacturer: no information may be released to third parties without written permission by the manufacturer. Descriptions and images in this document are only meant as indications and practical examples. They may be modified at any time and without prior notice. If further technical and functional details are needed, please contact the supplier.



Warning

Please, read the information contained in this booklet since they will provide you with useful instructions for safe installation, use and maintenance. Carefully read the sections “General information”, “Foreseen Operation Conditions”, “Incorrect Use”, “Forbidden Use”. This booklet is an integral part of the product. As specified by Directive 98/37EC, it shall be given to the users of the misting unit, in order to meet the obligations on training/information of the personnel using the machine. The manufacturer is not liable for any damage to people or goods, or to the machine itself, if the latter is used differently from what described in this manual. Keep this booklet in a safe place and make it available for future reference. Make sure it corresponds to the unit you have purchased, by checking the data on the machine identification plate. At delivery, check for any possible damages due to transportation. Complaints can be accepted only if reported by registered letter with return receipt within 8 days from product delivery date.

General information: Natural Cool

The misting unit cools the temperature through a physics process called “Adiabatic process” or “Thermal Dynamics”.

Water needs energy to evaporate, that is to pass from liquid to gaseous state. 1 g/0,03 oz of water needs 600 calories to evaporate. This energy is taken from the same room temperature where the water is nebulized, thanks to the high-pressure generated by the unit.

Because of their diameter of only 5 micron / 0,1969 mil, water particles evaporate almost immediately if the air condition is suitable. A suitable condition requires high temperatures and relative humidity not exceeding 90%. General efficiency of the system depends on temperature and relative humidity: between 30°C and 45°C – 86 °F and 115 °F with relative humidity below 40%, the naturalcool systems finds its best operating condition and achieves excellent results in heat reduction. Between 40% and 80% of relative humidity the results are still good, but above 80% of relative humidity they are marginal. The advantages offered by these products are best exploited in shaded or covered areas (verandas, gazebos, large umbrellas, marquees and the like). The misting unit, properly installed and set, allows reducing the heat by 4°C to 13°C – 39,2 °F to 55,4 °F. By combining the misting unit with special diffusers, such as wall or floor fans and special nozzles, it is possible to cool many different places and environments, both indoor and outdoor. Industrial buildings and areas, warehouses, vegetable and chilled food cabinets, farm businesses: these are only a few fields of application where you can have cool at low costs. Proper installation and adjustment of the system guarantee the best results in terms of performance and costs.

Machine description

The misting unit consists of an electric pump assembly, equipped with electrical and hydraulic safety systems. The on/off and pressure controls are located on the same unit. The machine mechanics is based on a ceramic-coated piston system, operated by an axial cam controlling the water flow at a pressure between 70 and 105 bar (100-1522 psi), allowing a water flow between 0.3 and 16.0 l/min (0,07 to 4,22 gal./min). Moreover, a patented by-pass system allows containing water flow backs without causing the water to overheat and thus avoiding incorrect evaporation. This system allows containing any pressure rise due to negligence that may compromise machine operation, thus considerably increasing its standard service life.

A pressure level out of the range mentioned above may seriously compromise the correct operation of the machine. The depressurization solenoid valve allows discharging excessive pressure, thus assuring the non-drip functionality and long efficiency of the seals. We suggest using High-Pressure lines, namely hoses and pipes with seal capacity 2 or 3 times higher than normal working pressure. This allows preventing water hammerings that may compromise the system seal. In case of special applications or use with particularly high pressure, please contact the manufacturer who will advise you on project feasibility, to avoid useless expenses or possible damages to components.

Package content

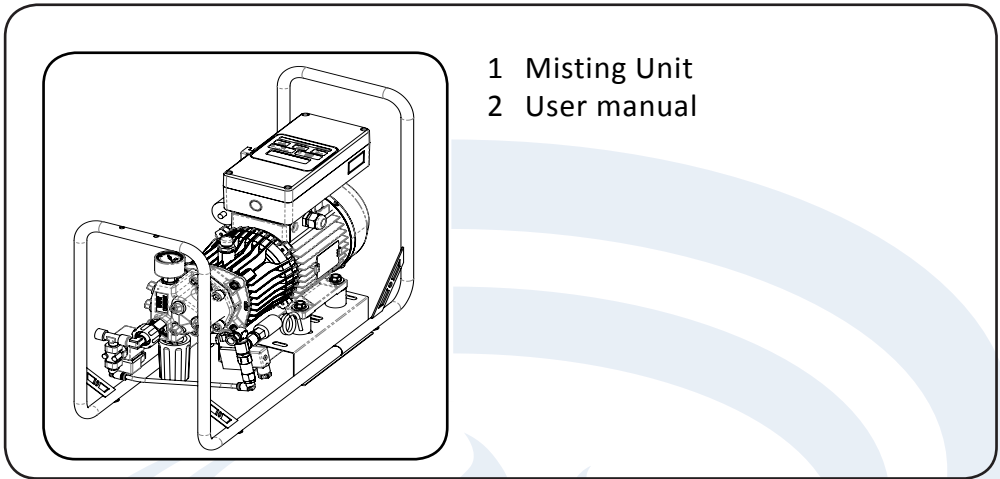

Machine description - control panel

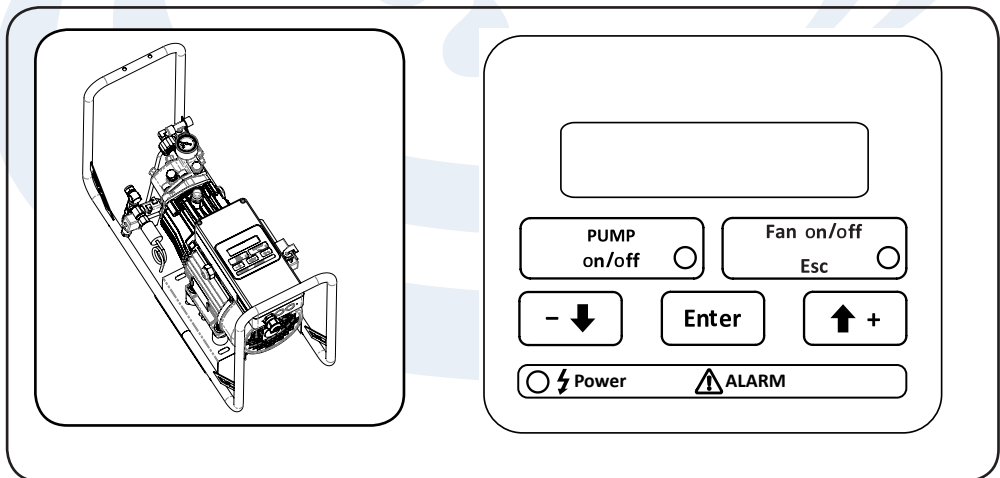

Machine description – electrical connections

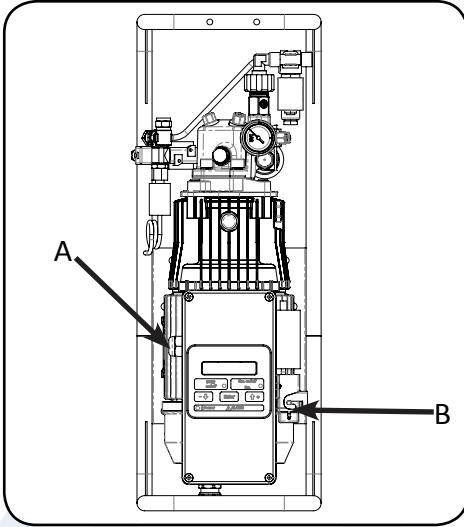

- A Power supply cable
- B Plug for fan and remote contact

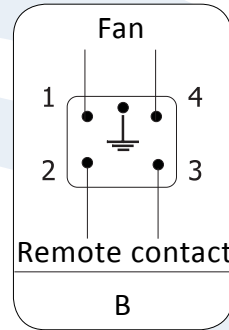

Machine description – water connections

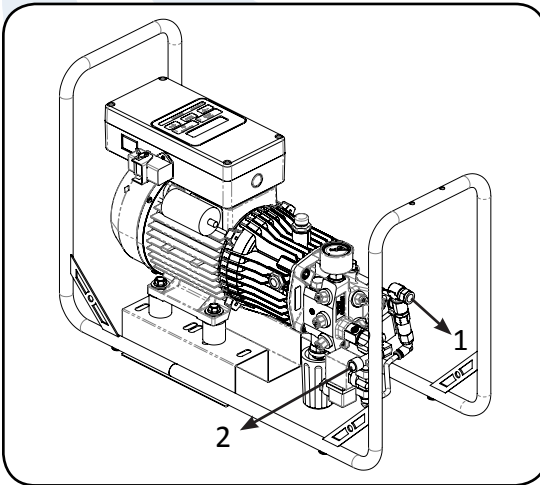

- 1 Water Inlet (2-4 bar / 30 – 60 psi) Sect. 3/4"
- 2 High-Pressure Water Outlet (70 – 105 bar / 1000 – 1500 psi)

Weight and dimensions

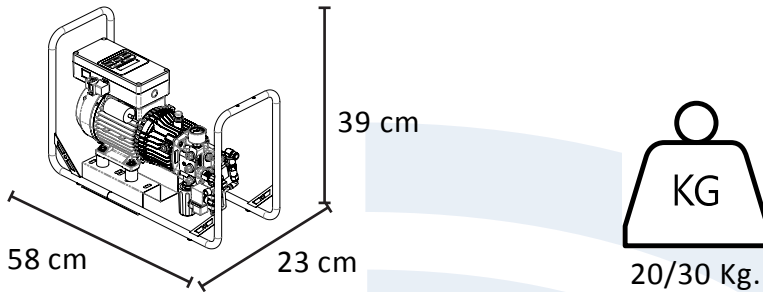

Transfer, packing and transportation

In case of first installation or misting unit's transfer please wear always working gloves and any other protective wearing to avoid any incidents or injuries. During transportation or transfer operations, the unit is placed on a pallet. Thus packed, the machine can be lifted by a lift truck with at least 100 Kg load capacity. If you need to transfer the machine but you do not have the original package, the unit should be correctly re-packaged and fastened to the means of transportation, in order to avoid impacts that may damage its external casing and compromise its functionality. In order to correctly restore machine operation after it has been transferred, changed of place or stored, the unit must be placed horizontally to avoid incorrect distribution of the lubricant, as this may cause faulty operation. Following this operation, disconnect the electrical supply and disassemble the machine. When putting the machine in its package, take care that its external parts and the external connections do not get damaged.



Installation position and start-up

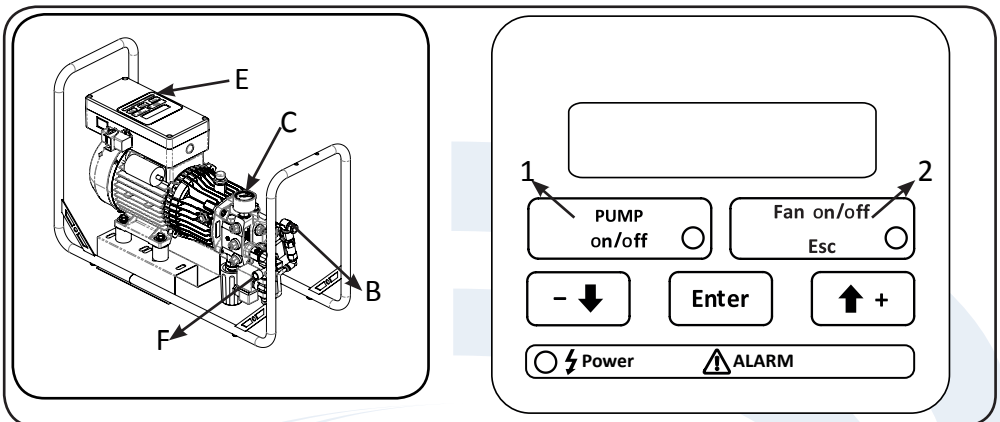

1. Place the misting unit away from the wall (50 cm/20 in) in a safe, accessible and dry place, out of the reach of unauthorized people. The place should be ventilated and protected against weather conditions and the control unit must not be placed under the sun. Room temperature must not be above 40°C / 104 °F. Also remember that dust compromises seal efficiency and increases clogging frequency of the micrometric nozzles.
2. Connect the supply hose from water network to water inlet connection (B). The use of a filter before making this connection is strongly recommended. If necessary install a softener or a reverse osmosis system. In the case of a filter installed we advise replace the filter cartridge every three months. Dirty or very hard water could need to be replaced more frequently.
3. Connect the high-pressure water outlet (F) to the high-pressure hose previously installed by a qualified technician.
4. Electrical supply (E): connect the unit to the electric panel equipped with a dedicated residual current device. Never operate the misting unit if the cables are damaged, incorrectly connected or if their section is unsuitable. If using power extension cables, keep to the following instructions: if the length of the power extension cable is between 1 and 25 m (3 ft and 80 ft), cable section should be 2.5 mm². (0,0039

sq in); if length is between 25 and 50 m (80 ft and 160 ft), cable section should be 4 mm² (0,0062 sq in). Never use power extension cables longer than 50 m (160 ft). Warning: section is 4 mm² (0,0062 sq in) and 6 mm² (0,0093 sq in) respectively for three-phase machines.

5. Check that the water pressure from the water network is between 2 and 5 bar (30 – 70 psi), then open the tap for machine supply.
6. If installed, leave the end of drain vent valve open, then power on the unit through switch (1) and let the water flow, thus expelling the air bubbles trapped in the misting line and in the pump. This operation requires 6-8 minutes. For further information about the best configuration of the misting line via electronic panel, please read the relevant instructions for use later on this guide.
7. After release the air, close the vent valve and check if the pressure gauge is showing a pressure of 70 bar (1000 psi), taking into consideration that pressure is stable after 15-20 minutes. If the indicator is visibly unstable, some air is still present in the system. Open again the end of line vent valve for a few seconds to expel the air, then close it again.
8. Within 5 minutes, the high-pressure line will start nebulizing water through the nozzles. If this does not happen, switch the system off following the instructions given and contact your supplier or the manufacturer.
9. Check proper seal/engagement of the nozzles. If pressure is considerably lower than 70 bar (1000 psi), this may be due either to poor water supply, leaking at the nozzles or end of line, or to the use of a number of nozzles greater than what foreseen in the original design. In such cases, contact your supplier.
10. In case of leaks from one or more nozzles, power off the system before disassembling them. After powering off, open the faulty nozzles and check for any foreign bodies, taking care not to lose the non-drip pin installed inside.
11. It is possible to activate only the fans by pressing the button (2) on the control panel.

12. The management control panel includes a number of safety settings for the misting line. We therefore recommend reading the relevant instructions for use later on this guide.

Warning



In case of lack of water supply, the machine is powered off automatically to avoid damages to the misting unit. In case of a current hogging due to a sudden voltage drop, use of an extension cable with a too small section (min. 2.5mm² / 0.0038 sq in) or work under the sun, the unit could automatically stop to protect the coil windings. In case, please contact the maintenance service or the supplier to replace the fuse inside of the electronic box. For this reason, we suggest checking that the electrical network is not affected by frequent and considerable voltage variations. If that were under the rated voltage of the electrical network for a long time, the control unit could be damaged.

Switching off and storing

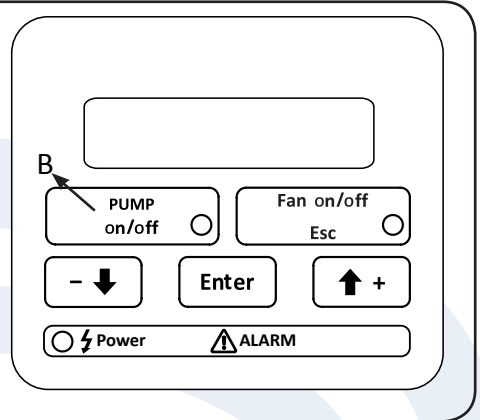
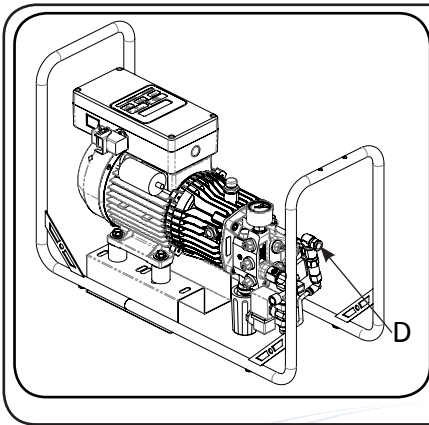

1. Close the water network tap to stop water supply. Warning: if you are using softener or an inverse osmosis system, switch off those devices too. Follow the instructions provided in the relevant manuals. Let the unit drain the water left in the system.
2. The unit switches off automatically when the water is completely drained. After that, use the machine main switch (B) to power off the misting unit.
3. When switching off the misting pump to clean the external filter or to recover the machine, detach the hydraulic hose which is connected to the input connector (D).
4. To store the machine, put it in a safe and dry place, out of the reach of unauthorized people. The storage place should be protected against weather conditions. If necessary, cover the unit for more protection.
5. When starting up the unit for the first time after a storage period, contact your supplier or a qualified technician. The scheduled routine maintenance allows including the annual storing and start-up operations as optional extra services.
6. During storage, the high-pressure lines and the filters must be completely drained in order to avoid incrustations or bacteria deposits. It is also advisable to disassemble, wash and store the micrometric nozzles. At next start-up, the lines should be washed by letting some

water flow before bringing the system to high-pressure.

Repairing the unit



No final user is allowed to carry out repairing operations on the Unit, otherwise the warranty shall immediately become null and void. In case a repair is needed, contact your supplier only, or ask for the intervention of a qualified technician authorized by the producer.

Routine maintenance - micrometric ceramic nozzles

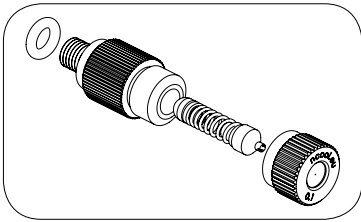

The only operation allowed on the misting line is cleaning the misting nozzles. If water nebulization is not uniform, the nozzle needs cleaning. Disassemble it, taking care not to lose the non-drip pin, then remove any foreign bodies by using compressed air. In case

of scale deposits, immerse the nozzle in a container filled with a descaling solution for at least 5 hours, then rinse it with water, dry it and store it for future use. Use cotton buds to remove any dust from the inside. In case of prolonged downtime of more than 30 days, remove the nozzles and drain the line. If room temperature is below 5°C, remove the misting nozzles from the line. If the internal non-drip pin is lost or damaged, this could result in small dripping when switching off the system, or bad nebulization. The fineness of nebulization is given by the pressure (70 bar min) and the condition of the nozzle. Replace the nozzle if the nebulization is excessive or dampens, even if room temperature is above 28°C.

Routine maintenance - oil change

Every time the machine make a warning for maintenance, please call a maintenance service in order to change the oil.

Warning



Always disconnect the electrical supply before servicing or checking the machine.

Troubleshooting – causes and solutions

Symptom	Cause	Solution
The lines under pressure visibly vibrate:	<ol style="list-style-type: none"> 1. Dirty water filters 2. One or more nozzles clogged 3. Air in the pipes 	<ol style="list-style-type: none"> 1. Clean or replace the filters 2. Disassemble and clean the nozzles 3. Open the end of line valve to expel the air from the pipe
The misting unit is pumping but no water comes out of the high-pressure line.	<ol style="list-style-type: none"> 1. Air in the water circuit 2. End of line open or leakage in the circuit 3. Tampering with the flow adjustment knob or the by-pass in the machine head 4. Several nozzles clogged 	<ol style="list-style-type: none"> 1. Expel the air from the line 2. Find and repair the leakage 3. Ask for the intervention of the supplier or authorized technician 4. Switch off the misting unit, clean or replace clogged nozzles
The misting unit does not activate when the start button is pressed	<ol style="list-style-type: none"> 1. No electrical supply 2. The residual current device has triggered 3. Incorrect electrical connections or cables of unsuitable size 4. No water (green indicator light on) 	<ol style="list-style-type: none"> 1. Check the electrical connection 2. Lift the switch and start the unit 3. Check cable diameter, extension cable length and electrical connections 4. Open the water network tap. Check if the filter is clean and if water flows freely through it. Make sure the water flow is correct

Lucky3 - General information

The programmable electronic device provided with Lucky3 technology is a component used for several configurations and products by the manufacturing company.

In this section of the manual we illustrate the use of the electronic device Lucky3 and explain how to fully exploit its technology through a number of operating modes: we recommend you follow the explanations and, where applicable, to carry out the tests you may find useful in the order in which they are proposed in this manual.

Never leave the misting unit or the multifunction display Lucky3 under direct sunlight.



Lucky3 - Meaning of buttons

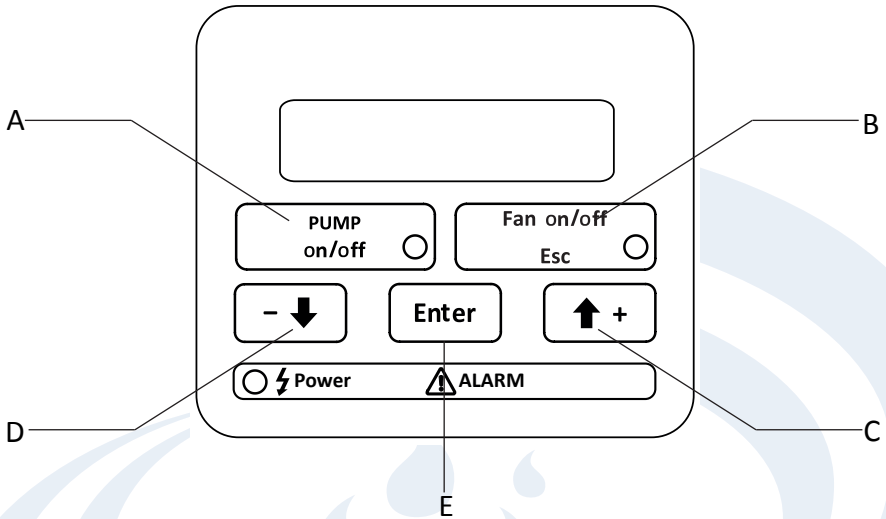

A	Pump on/off /Alarms Reset
B	Fan on/off
C	Change Menu/shift between options and value change (+1)
D	Change Menu/ shift between options and value change (-1)
E	Confirm set value

Warning



The function keys C-D-E have different functions and modes. Their function varies according to what is displayed on the screen.

Lucky3 - Available programs

The electronic device Lucky3 consists of:

1. 1 Dashboard page for the management of the nebulization.
2. 7 information pages.
3. 8 Weekly program pages.
5. 5 Alarm registry pages.

This guide will provide, in the next pages, a description for each program, specific settings and details about information pages.

Lucky3 - Shift and program selection

In order to display the different programs use button C (forward) and D (backward).

From the menu you can select the desired function.

Lucky3 - Shift and options page selection



Every page can contain different changeable options. To enter the “change setting” function press button E (enter). To move between changeable settings press button E (enter) again. The box which contains the value will start flashing, so it means you can modify the value by pressing button C (+) and D (-). To confirm the value you have chosen press button E. The box will stop flashing and will show the set value and the active value at that moment.

Warning



The indications mentioned above provide a detailed description about how to select the program and the single option for each of them. It is assumed that this information is clear and acquired, so it will be only indicated to which program and to which option page you have to go without explaining what operations to perform.

We will use the following icons in order to identify the item which can only be consulted and the changeable one

- | | |
|---|-------------------------------------|
|  | <i>Content only to be consulted</i> |
|  | <i>Changeable content</i> |

Lucky3 - Dashboard program

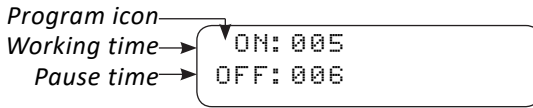

Detailed description

In the Dashboard program you can select/execute the following operations:

1. Access to the program selection menu and change settings
2. Activate the control unit according to the visible set-up set
3. Operate the fans, if connected and enabled from panel
4. Set cyclic timer and relative times ON/Work and OFF/Pause
5. Delete any previous alarms, appearing on the display





To access the program selection menu and change settings press the C or D buttons. Pressing button A the control unit activates and nebulizes, consistent with the settings entered. An icon on the left of the ON/Working time indicates the active program. By pressing button B the Fans are activated even in the absence of nebulization. This option can be activated in the “Settings” program. An icon on the display confirms its activation. To change the ON/OFF time Work/Pause press the E button. The minimum time allowed is 3”, the maximum time allowed is 999”. If you set the value of ON/Labour below 3”, the message “CON” appears, which means Continuous Nebulization. The control unit will operate without cyclic intervals

Warning



Data shown could be different from what is displayed on the screen you have since it could show other language descriptions or values with a different standard of measurement

Lucky3 - Info program

 <i>Partial and total nebulizer working time</i>	→	<pre>1.01 Pmp t. P/T 0:15/ 20:26</pre>
 <i>Partial and total fan working time</i>	→	<pre>1.02 Fat t. P/T 0:10/ 23:40</pre>
 <i>Date of last maintenance done</i>	→	<pre>1.03 Last maint. 01/01/2020</pre>
 <i>Hours to next maintenance</i>	→	<pre>1.04 Next maint. 600 h</pre>

Access

The Info Program is at position 1. It totally has 7 options pages for a total of 7 summary screens in this page and in the following one.

Detailed description

The “INFO” program shows the partial and total times of the activity carried out by the control unit and the fans. The partial time is the time that elapses between one maintenance and the next or between any interventions that may be necessary.

The total time corresponds to the actual value of the nebulization activity starting from the test.

The screen also indicates the date of the last maintenance and the hours until the next one.

The information is completed by the serial number of the control unit and the active firmware version. If set by the set-up program the suitable

Warning



Data shown could be different from what is displayed on the screen you have since it could show other language descriptions or values with a different standard of measurement

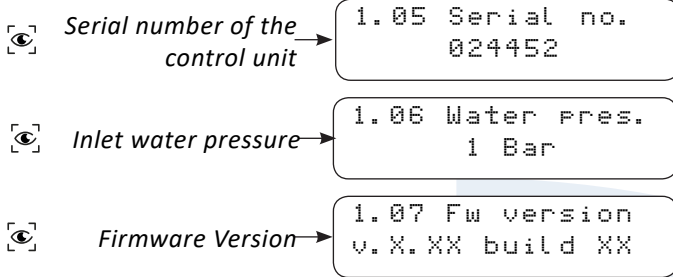

pressure switch, it is possible to have reading of the pressure of the water entering from the mains supply to which you are connected.

Warning



Data shown could be different from what is displayed on the screen you have since it could show other language descriptions or values with a different standard of measurement

Lucky3 - Setup program

<input checked="" type="checkbox"/> Presence of connected fans	→	2.01 Fans ON
<input checked="" type="checkbox"/> Draining time	→	2.02 Drain time 5s
<input checked="" type="checkbox"/> Fan delay	→	2.03 Fan delay 5s
<input checked="" type="checkbox"/> Remote contact enabling	→	2.04 Rem. switch OFF

Access

The Setup Program is at position 2. It totally has 11 options pages for a total of 11 summary screens in this page and in the following pages.

Detailed description







The following functions can be set in the Set-up program:

- Enable/disable fans
- Line venting time
- Fans switch on with delayed start of nebulization (prevents dripping)
- Activating/deactivating the remote control signal
- Change DATE/TIME
- Selection of pressure switch type and activation of over/under pressure alarms
- Enable/disable AUTO-RESTART function for automatic start after

Warning



Data shown could be different from what is displayed on the screen you have since it could show other language descriptions or values with a different standard of measurement

	Current date →	2.05 Date Wed 01/01/20
	Current time →	2.06 Time 00:01
	Check pressure switch alarms →	2.07 Pres. switch ON
	Pressure switch type →	2.08 Press. type DIG
	Pressure switch alarm range (if analogue) →	2.09 Press. alm. <02 >06
	Auto restart enabling →	2.10 Auto rest. OFF
	Interface language selection →	2.17 Language English

power failure.

- Interface language selection (ENG/ITA/FRA/ESP)

Warning



Data shown could be different from what is displayed on the screen you have since it could show other language descriptions or values with a different standard of measurement

Lucky3 - Weekly program

 *Enable/Disable weekly program* →

3.01 Weekly
ON

 *Enabling 1st day of the week and timetables* →

3.02 Monday
OFF 00:01-23:59

 *Enabling 2nd day of the week and timetables* →

3.03 Tuesday
OFF 00:01-23:59

 *Enabling 3rd day of the week and timetables* →

3.04 Wednesday
OFF 00:01-23:59

Access

The Weekly Program is at position 3. It totally has 8 options pages for a total of 8 summary screens in this page and in the following pages.

Detailed description

The weekly program with “Agenda” function allows you to set a unique daily schedule or choose to set each day of the week with different times and bands. In order to activate the daily setting function, the weekly operation must in any case be enabled, and then subsequently vary the single day desired.

Warning



Data shown could be different from what is displayed on the screen you have since it could show other language descriptions or values with a different standard of measurement

- Enabling 4th day of the week and timetables* →

3.05	Thursday
OFF	00:01-23:59
- Enabling 5th day of the week and timetables* →

3.06	Friday
OFF	00:01-23:59
- Enabling 6th day of the week and timetables* →

3.07	Saturday
OFF	00:01-23:59
- Enabling 7th day of the week and timetables* →

3.08	Sunday
OFF	00:01-23:59

Warning



Data shown could be different from what is displayed on the screen you have since it could show other language descriptions or values with a different standard of measurement

Lucky3 - Alarm registry program

 Recorded alarm detail →

```
4. XX No  
alarm res.
```

Access

The Alarm Registry program is at position 4. It totally has 5 options pages for a total of 5 summary screens. Each page is identical to the first one so we cover only one.

Detailed description

Alarm pages show date, time and type of anomaly recorded by the system

Warning



Data shown could be different from what is displayed on the screen you have since it could show other language descriptions or values with a different standard of measurement

Foreseen operation conditions

The machine has been designed and manufactured to be used both indoor and outdoor, in parks, industrial buildings, farm businesses and the like. If the machine is installed indoor, check that the area is not dusty and that is properly ventilated in order to allow correct cooling. Therefore, the ideal installation place for the machine is in ventilated areas protected against weather conditions, at a temperature above 27-28°C with relative humidity below 80%. If you use the system both for Summer cooling and Winter humidification, it is advisable to adjust the water flow. For the humidifier function, use the cyclic timer to decrease the nebulization according to a time unit, so that the operation in a minute is limited to 5, 10 or 15 seconds, according to the humidity level to be reached. In summer, you will just need to set the continuous operation again. To perform this operation, contact the manufacturer authorized technician.

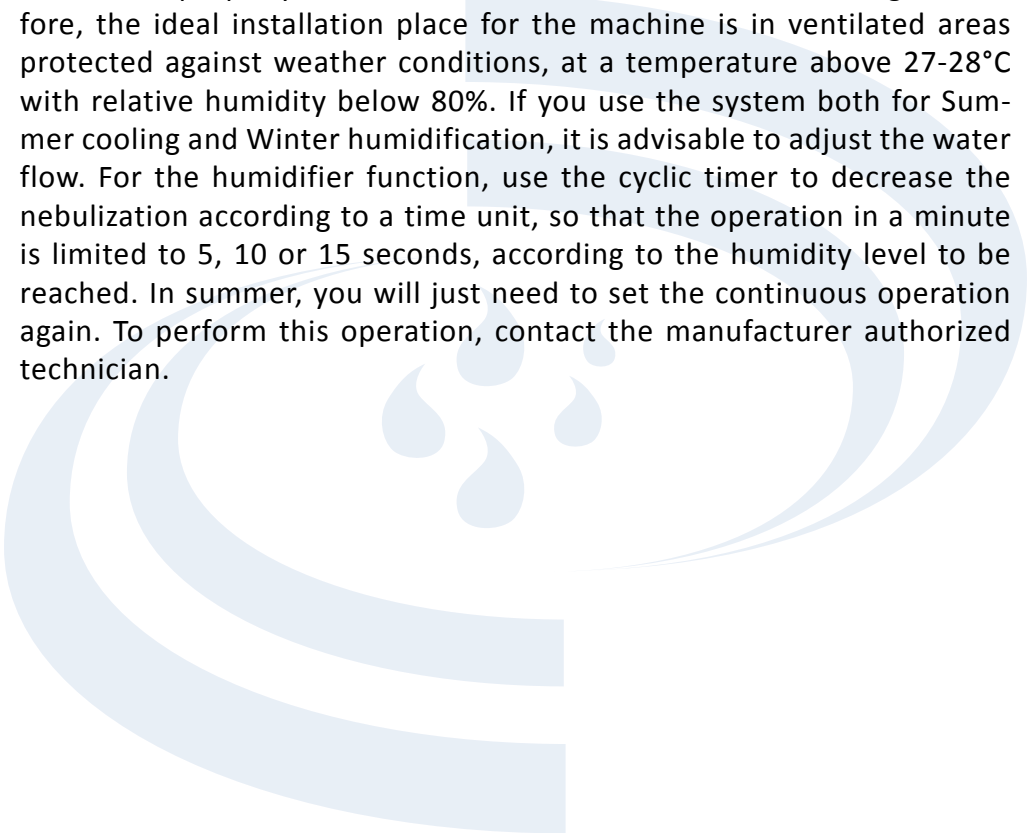

Improper use – forbidden use

1. It is absolutely forbidden to carry out checks or maintenance operations when the machine is running or the power supply is on. **ALWAYS DISCONNECT THE POWER SUPPLY!**
2. Do not expose the machine to low temperatures: ice formation may cause serious damages to the high-pressure pump.
3. Always wear protection equipment when servicing the machine.
4. When using the misting unit to nebulizer liquids other than water, make sure that they can be completely nebulized and that they do not contain any substance that might harm people in the area. Moreover, make sure **NOT** to nebulizer substances containing alcohol, oil or particles greater than 5 micron, in order to avoid deteriorating or clogging the micrometric nozzles and the mechanical components of the unit. The manufacturing company is no way liable and does not grant the warranty for any damage to people or goods due to incorrect use of the unit, namely when it is used to nebulizer in the air substances that are not allowed by the law in force or by the manufacturer.

Warning



DO NOT REMOVE THE LABELS FROM THE MACHINE. IF THEY ARE DETERIORATED, ASK THE SUPPLIER FOR NEW ONES. THE MANUFACTURER AND THE SUPPLIER ARE NOT LIABLE FOR BREAKAGES OR ACCIDENTS DUE TO NON COMPLIANCE WITH THE WARNINGS ABOVE. WARRANTY WILL BE CONSIDERED NULL AND VOID IF THE ABOVE-MENTIONED WARNINGS ARE NOT FOLLOWED.

Warranty terms and conditions

Validity

This product is covered by a twenty-four (24) months warranty, starting from the purchase and/or test date. This warranty protects the user against manufacturing or material defects. In case the machine is used for professional applications, this warranty covers a period of twelve (12) months (ex C.L. no°422 art.1 par. B).

Warranty Conditions

1. The in-warranty repair is accepted only if the product is accompanied by the purchase receipt and the test report issued by the supplier.
2. Manufacturing company duty is limited to the repair and, at its own discretion, the replacement of the whole product or of single faulty components.
3. The suppliers and the technicians allowed to carry out in-warranty repairs are only those expressly authorized by the manufacturer
4. This product or its materials are not considered as faulty in case the customer needs to adapt the machine to technical or national safety regulations other than those in force in the country originally foreseen for the product. No refund shall be granted for damages arising from the above-mentioned modifications, or other changes not connected to the original design of the product, carried out by the customer/user or by unauthorized people.
5. The warranty does not apply to:
 - a. Periodical checks, maintenance operations, replacement of components subject to wear;
 - b. Transport, transfer or installation of the product;
 - c. Damages caused by fire, water, natural events, war and riots, incorrect power supply, insufficient ventilation of the installation place, and any other cause not connected the manufacturer;
 - d. Incorrect use, operating errors and wrong or unwary installation;
 - e. Damages to the product due to non original manufacturer spare parts use;

- f. Damages to the product or insufficient performance due to incorrect installation after purchase;
 - g. Every damage to the product due to negligence.
6. This Warranty is valid for every person formally having the propriety of the product during the above-mentioned period.
7. This Warranty does not affect the rights of the customer as prescribed by the law in force in the country, nor the rights of the customer towards the retailer arising from the contract of sale.

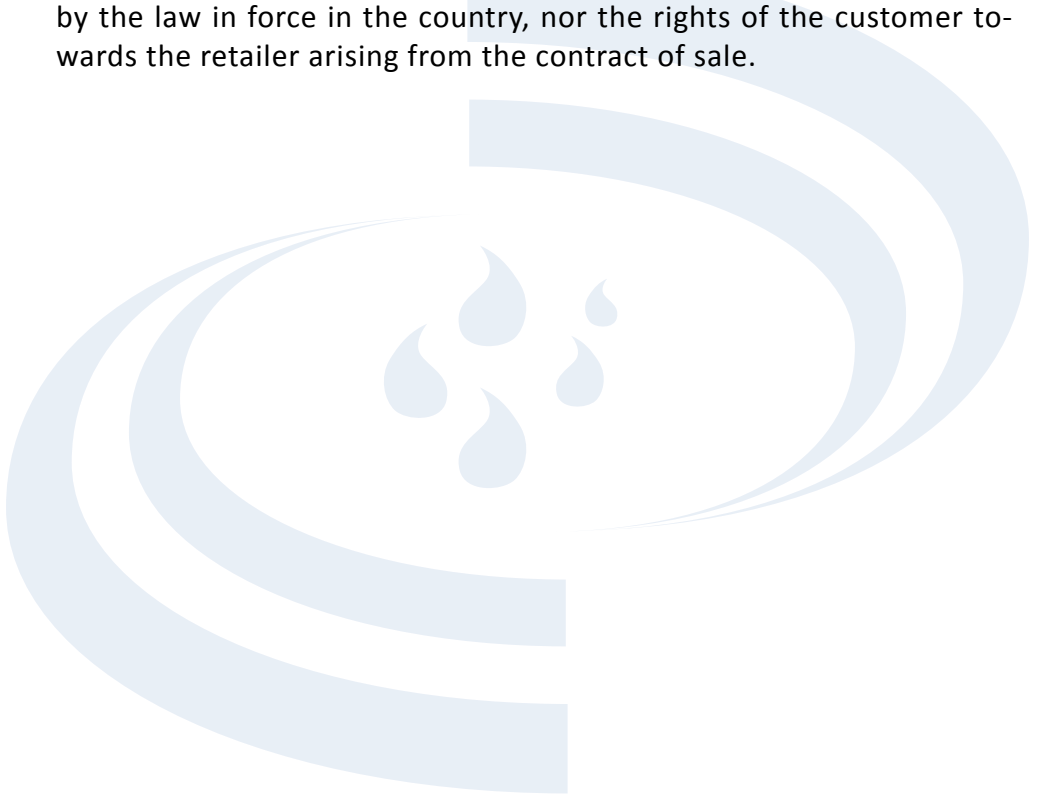

Declaration of conformity

I, the undersigned, acting legal representative of the company

Declare that the following appliances:

PROFY ADVANCE

Comply with the current laws in force, which implement the following directives and also declare that all the following regulations and/or technical specifications have been applied:

2004/108/CE EMC

EN 61000-3-2/A2:2009

EN 61000-3-3:2008

EN 55014-1/A1:2009

EN 55014-2/A2:2008

2006/42/CE Machinery

EN 60335-1:2010

EN 60335-2-79:2009

EN 62233:2008

EN ISO 12100-1/A1:2009

EN ISO 13857:2008



Note



